

PACCAR

Engine Aftertreatment Systems

Operator's Manual

2024 Emissions

Safety	1
Engine Aftertreatment System	2
Indications and Controls	3
Aftertreatment Operations	4
Maintenance	5
Quick Reference Tables	6

© 2023 PACCAR Inc. - All Rights Reserved

This manual illustrates and describes the operation of features or equipment which may be either standard or optional on this vehicle. This manual may also include a description of features and equipment which are no longer available or were not ordered on this vehicle. Please disregard any illustrations or descriptions relating to features or equipment which are not on this vehicle. PACCAR reserves the right to discontinue, change specifications, or change the design of its vehicles at any time without notice and without incurring any obligation. The information contained in this manual is proprietary to PACCAR. Reproduction, in whole or in part, by any means is strictly prohibited without prior written authorization from PACCAR Inc.

Chapter 1 | SAFETY

Using this Manual.....	5
Safety Messages and Notes.....	5
Illustrations.....	6
General Safety Instructions.....	6

Using this Manual

Please take the time to get acquainted with your vehicle by reading this Operator's Manual. We recommend that you read and understand this manual from beginning to end before you operate this equipment. This manual contains useful information for the safe and efficient operation of this equipment. It also provides service information, with an outline for performing safety checks and basic preventive maintenance inspections. When replacement parts are needed, we recommend using only genuine PACCAR parts.

We have tried to present the information needed to learn about functions, controls, and operation—and to present it as clearly as possible. Occasionally, you may need to reference this manual, and we hope you find it is easy to use.

	NOTE
After you've read this manual, it should be stored in the cab for convenient ref-	

erence and remain with this truck when sold.

Your vehicle may not have all the features or options mentioned in this manual. Therefore, you should pay careful attention to the instructions that pertain to just your vehicle. In addition, if your vehicle is equipped with special equipment or options not discussed in this manual, consult your dealer or the manufacturer of the equipment.

There are several tools built into this manual to help you find what you need quickly and easily; first is the Table of Contents. Located at the front of the manual, this table arranges the subject matter into chapters, which can be quickly referenced using the numbers shown in the outer margin. The first page of each chapter presents a list of the major subjects contained in that chapter. Cross-referenced citations can also help you find information. If more information on the current subject is located elsewhere in the manual, a cross-reference may be provided, such as "see [Safety Messages and Notes](#) on page 5." Finally, you'll find a helpful index at the back of the manual which lists the subjects covered alphabetically.

All information contained in this manual is based on the latest production information available at the time of publication. If you find differences between your instruments and the information in this manual, contact a PACCAR Powertrain distributor. PACCAR reserves the right to make changes at any time without notice.

Safety Messages and Notes

Read and follow ALL safety messages in this manual. When followed, injury to yourself and others, damage to equipment and/or property, or other unknown hazards are reduced. Both safety messages and notes are emphasized using a safety message symbol and one of three signal words: WARNING, CAUTION, or NOTE. **Do not** ignore any of these messages.

Warnings



Safety messages that follow this symbol and signal word provide a warning against operating procedures, actions, or a lack of action that could result in death or injury.

An unheeded warning may also result in damage to equipment, property, or the environment. Warning messages will identify the hazard, how to avoid it, and the probable consequence of not avoiding the hazard.

Example:



WARNING

DO NOT change hot engine oil as you could be burned. Let the engine cool down before changing the engine oil. Failure to comply may result in death, personal injury, equipment damage, or property damage.

Cautions



Safety messages that follow this symbol and signal word provide a caution against operating procedures, actions, or a lack of action that could result in equipment, property, or environmental damage. Caution messages will identify the hazard, how to avoid it, and the probable consequence of not avoiding the hazard.

Example:



CAUTION

DO NOT operate your vehicle with insufficient oil pressure as this will cause serious engine damage. Failure to comply may result in equipment or property damage.

Notes



Messages that follow this symbol and signal word provide important information that, while not safety related, should still be followed. A note will provide information that may be useful to the reader: clarifying the topic, providing valuable insight into the topic or process, or saving the reader time and effort.

Example:



NOTE

Pumping the accelerator pedal will not assist in starting the engine.

Illustrations

Some of the illustrations found in this manual are generic, and may not look exactly like the parts or assemblies you find installed on your vehicle.

When an illustration differs from what you see physically present on your vehicle, the language describing the procedure will still be correct for your application.

General Safety Instructions



WARNING

Improper practices, carelessness, or ignoring safety messages – Warnings and Cautions – may cause death, personal injury, or equipment and property damage.

Before performing any repair, read and understand all of the safety precautions and warnings. The following is a list of general safety precautions that must be followed to provide personal safety. Failure to follow these instructions may cause

death or injury. Special safety precautions are included in the procedures when they apply.

Keep in mind that even a well maintained vehicle must be operated within the range of its mechanical capabilities and the limits of its load ratings. See the Weight Ratings label on the driver's door edge.

Every new vehicle is designed to conform to all Federal Motor Vehicle Safety Standards applicable at the time of manufacture. Even with these safety features, continued safe and reliable operation depends greatly upon regular vehicle maintenance. Follow the maintenance recommendations found in the Preventive Maintenance section. This will help preserve your investment.

Make sure your vehicle is in top working condition before heading out on the road, it is the responsible driver's duty to do so. Inspect the vehicle according to the Driver's Check List:

- Work areas should be dry, well lit, well ventilated; free from clutter, loose tools, parts, ignition sources, and hazardous substances.
- Wear protective glasses and protective shoes when working.
- Wear protective gloves when working with hot liquids or

surfaces, and when working with components that have sharp edges.

- DO NOT wear loose-fitting or torn clothing. Tie back and/or tuck in long hair. Remove all jewelry when working.
- Before beginning any repair, disconnect the battery (negative [-] cable) and discharge any capacitors.
- Put a "DO NOT OPERATE" tag in the operator's compartment or on the controls.
- Allow the engine to cool before slowly loosening the coolant fill cap to relieve the pressure from the cooling system.

	WARNING
<p>Removing the fill cap on a hot engine can cause scalding coolant to spray out and burn you badly. If the engine has been in operation within the previous 30 minutes, be very careful in removing the fill cap. Protect face, hands, and arms against escaping fluid and steam by covering the cap with</p>	

a large, thick rag. DO NOT try to remove it until the surge tank cools down or if you see any steam or coolant escaping. Always remove the cap very slowly and carefully. Be ready to back off if any steam or coolant begins to escape. Failure to comply may result in death, personal injury, equipment or property damage.

- Always use wheel chocks or proper jack stands to support the vehicle or vehicle components before performing any service work. DO NOT work on anything that is supported only by lifting jacks or a hoist. Before resting a vehicle on jack stands, be sure the stands are rated for the load you will be placing on them.
- Before removing or disconnecting any lines, fittings, or related items, relieve all pressure in the air, oil, fuel, and cooling systems. Remain alert for possible pressure when disconnecting any device from a system that contains pressure. High-pressure oil or fuel can cause death or personal injury.

- Always wear protective clothing when working on any refrigerant lines and make sure that the workplace is well ventilated. Inhalation of fumes can cause death or personal injury. To protect the environment, liquid refrigerant systems must be properly emptied and filled using equipment that prevents the release of refrigerant gas. Federal law requires capturing and recycling refrigerant.
- When moving or lifting any heavy equipment or parts, make sure to use proper techniques and assistance. Ensure all lifting devices such as chains, hooks, or slings are in good condition and are rated for the correct load capacity. Make sure all lifting devices are positioned correctly.
- Corrosion inhibitors and lubricating oils may contain alkali. DO NOT get the substance in eyes and avoid prolonged or repeated contact with skin. DO NOT swallow. If ingested, seek immediate medical attention. DO NOT induce vomiting. In case of contact, immediately wash skin with soap and water. In case of harmful contact, immediately contact a physician. Always keep any chemicals OUT OF REACH OF CHILDREN.
- When working on the vehicle, be alert for hot parts on systems that have just been turned off, exhaust gas flow, and hot fluids in lines, tubes, and compartments. Contact with any hot surface may cause burns.
- Always use tools that are in good condition. Make sure you have the proper understanding of how to use the tools before performing any service work. Use only genuine replacement parts from PACCAR.
- Always use the same fastener part number (or equivalent) when replacing items. DO NOT use a fastener of lesser quality if replacements are necessary. (e.g., DO NOT replace a Metric 10.9 grade with 8.8 grade fastener).
- Always torque fasteners and fuel connections to the required specifications. Overtightening or under-tightening can allow leakage.
- Close the manual fuel valves prior to performing maintenance and repairs, and when storing the vehicle inside.
- DO NOT perform any repair when impaired, tired, fatigued, or after consuming alcohol or drugs that can impair your functioning.
- Some state and federal agencies in the United States of America have determined that used engine oil can be carcinogenic and can cause reproductive toxicity. Avoid inhalation of vapors, ingestion, and prolonged contact with used engine oil.
- Coolant is toxic. If not reused, dispose of coolant in accordance with local environmental regulations.

**CAUTION**

Corrosive chemicals can damage the engine. DO NOT use corrosive chemicals on the engine. Failure to comply may result in equipment or property damage.

California Proposition 65 Warning

- Diesel engine exhaust and some of its constituents are known to the State of California to cause cancer, birth defects, and other reproductive harm.
- The catalyst substrate located in the Diesel Particulate Filter (DPF) contains vanadium pentoxide, which has been determined by the State of California to cause cancer. Always wear protective clothing and eye protection when handling the catalyst assembly. Dispose of the catalyst in accordance with local regulations. If catalyst material gets into the eyes, immediately flood eyes with water for a minimum of 15 minutes. Avoid prolonged contact with skin. In case of contact, immediately wash skin with soap and water. In case of harmful contact, immediately contact a physician.
- Other chemicals in this vehicle are also known to the State of California to cause cancer, birth defects or other reproductive harm.
- Battery posts, terminals, and related accessories contain lead

and lead compounds, chemicals known to the State of California to cause cancer and reproductive harm. Wash hands after handling.

Chapter 2 | ENGINE AFTERTREATMENT SYSTEM

Engine Aftertreatment System (EAS).....	11
Vehicle Emission Controls.....	11
Canister Characteristics.....	12
Diesel Particulate Filter (DPF) System.....	13
Diesel Exhaust Fluid (DEF).....	14
Selective Catalytic Reduction (SCR) System.....	18
Heater Control Unit (HCU) MX-13 (CARB Only).....	19
48 V Generator (CARB Only).....	19

Engine Aftertreatment System (EAS)

The Engine Aftertreatment System (EAS) 2024 has configurations that are specifically designed to meet the US Environmental Protection Agency (EPA), California Air Resources Board (CARB) emission requirements, and Greenhouse Gas (GHG) regulations requirements. Any changes to component locations or modifications of any EAS components may reduce the emission effectiveness and you may be subject to fines under the United States Clean Air Act.

Vehicle Emission Controls

This vehicle has an Engine Aftertreatment System (EAS) to control vehicle exhaust emissions. The EAS consists of the following:

- Diesel Particulate Filter (DPF)
- 48 V generator (CARB only)
- Urea Quality Sensor (UQS)
- Selective Catalytic Reduction (SCR)
- Diesel Exhaust Fluid (DEF) filter

- DEF coolant filter
- DPF switch
- Warning lights

The DPF filters soot from the engine exhaust gases. The SCR uses Diesel Exhaust Fluid (DEF) to reduce the levels of Nitrogen Oxides (NOx) in the engine exhaust. The EAS will periodically clean (regenerate) the DPF.

Engine Aftertreatment System Detail

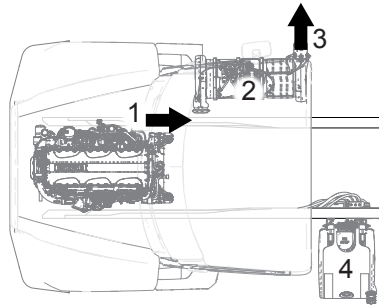

1. Hydrocarbon doser/in-cylinder dosing
2. Single module canister/compact twin canister (DPF, DEF doser, and SCR)
3. Filtered/treated exhaust

4. Diesel Exhaust Fluid (DEF) tank
- There are two type of canisters to comply with EPA emissions (single module canister) and with CARB emissions (compact twin canister).

Single Module Canister

- Single module canisters are available on all engines except on PACCAR MX-13 CARB engines.
- Additional components as needed to meet the requirements of EPA.

Compact Twin Canister

- Compact twin CARB canisters are only available on PACCAR MX-13 CARB engines.
- CARB systems on PACCAR MX-13 engines have a 48 V electric exhaust grid heater system that utilizes a 48 V generator located between the engine and the transmission, and 48 V connections for CARB emissions.
- Cooling subsystem fed by the engine cooling system to cool the generator.
- Additional components as needed to meet the requirements of CARB.

2

Canister Characteristics

Your vehicle is equipped either with a single module canister (EPA compliant) or a compact twin canister (CARB compliant).

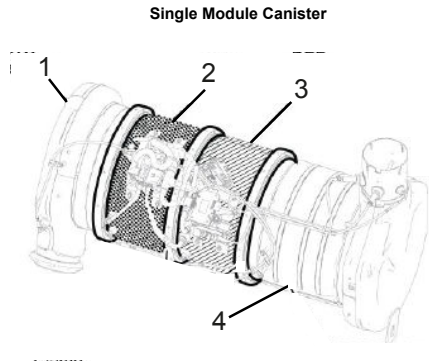

Compact Twin Canister

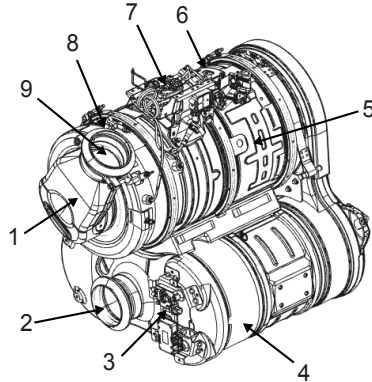

1. Inlet/48 V heater/DOC
2. Exhaust outlet
3. Canister NOx and PM sensors
4. SCR section
5. Mixer
6. DEF doser
7. DPF sensor table
8. DPF section
9. Canister inlet

	NOTE
<p>Refer to your engine manufacturer's Operator's Manual for service interval of the DPF (compact twin canister).</p>	

Diesel Particulate Filter (DPF) System

The Diesel Particulate Filter (DPF) system consists of the following:

- Hydrocarbon (HC) doser
- Diesel Oxidation Catalyst (DOC)

- Diesel Particulate Filter (DPF)

As the DPF fills with particulate, the system will activate the HC doser, spraying diesel fuel (the HC) into the exhaust stream. The HC reacts with the DOC, generating heat to a sufficient temperature, and converts the soot into carbon dioxide and ash. This process is called active regeneration.

A vehicle with a DPF system has three additional warning lights and one additional gauge. These additional indications, along with the check engine light, can inform the status of the DPF system to the operator.



CAUTION

Do not submerge or allow water to enter the DPF assembly. Components of the assembly can be damaged and affect the performance of the aftertreatment system. Failure to comply may result in equipment or property damage.



NOTE

For Diesel Particulate Filter (DPF) maintenance information, refer to your engine manufacturer's Operator's Manual.

Diesel Particulate Filter (DPF)

The Diesel Particulate Filter (DPF) traps particulate matter (soot) from the exhaust. As soot fills the filter, the DPF warning light will either flash, change color, or both to

denote stages of accumulated soot (see [Diesel Particulate Filter \(DPF\)](#) on page 28). The soot that accumulates in the DPF will eventually need to be removed (see [Regenerations](#) on page 37). It is important that the operator plan to regenerate the DPF when the DPF warning light appears.

The DPF uses regenerations to “self-clean,” burning off the accumulated soot and leaving ash (a byproduct of burning soot). This ash will eventually fill the DPF, requiring it be serviced (see [Diesel Particulate Filter \(DPF\) Service Strategy](#) on page 49).

Periodically, the DEF pump filter will need to be replaced (see [DEF Pump Filter Replacement](#) on page 53). See the Engine Operator's Manual for the DEF filter maintenance interval.

Diesel Exhaust Fluid (DEF)

Diesel Exhaust Fluid (DEF) is a colorless, moderately corrosive, non-toxic, non-polluting, non-flammable liquid used to reduce the levels of Nitrogen Oxides (NOx) in the engine exhaust. DEF has a slight ammonia smell.

DEF passes through a filter in the DEF dosing unit (DEF module). This filter keeps the system clear of debris, which would negatively affect the EAS system. The DEF filter should be replaced routinely (see your engine operator's manual for frequency). DEF is contained in a separate tank on the vehicle, and the fluid level in the tank is shown on a gauge located on the dash (see [Diesel Exhaust Fluid \(DEF\) Level Gauge](#) on page 23). DEF is consumable and must be replenished, so monitor the DEF level gauge as you would the fuel level gauge.

The following are other common names used for DEF:

- Aqueous Urea Solution 32 (AUS 32)
- AdBlue
- NOx Reduction Agent
- Catalyst Solution
- Urea

Vehicles operating in the United States or Canada using SCR-equipped engines are advised to use DEF that is certified by the American Petroleum Institute (API); furthermore, PACCAR Inc. recommends the use of TRP® CleanBlue Diesel Exhaust Fluid, which is available in different

quantity options from small to bulk containers.

 **CAUTION**

Only use diesel exhaust fluid (DEF) that meets ISO 22241-1 (DIN 70070) specifications. There is NO acceptable substitute. Failure to use the correct DEF may cause aftertreatment system damage and/or void the warranty.

 **NOTE**

The DEF tank size is determined by the engine, fuel capacity, and DEF-fuel ratio.

DEF Handling

 **CAUTION**

Diesel Exhaust Fluid (DEF) is corrosive. If DEF is spilled on metal surfaces (for example, the steps, fuel tanks, or grab handles), rinse and clean immediately with water. Failure to do so may leave

permanent corrosive stains on the metal surfaces that cannot be removed.

- Avoid prolonged contact with skin. In case of contact, wash immediately with soap and water.
- Use only approved containers to transport and store DEF; polyethylene and polypropylene are recommended.
- If DEF is spilled, rinse and clean immediately with water. If not cleaned immediately, a white residue will remain when the DEF dries.

 **CAUTION**

Do NOT add water or any fluid other than DEF that meets ISO 22241-1 (DIN 70070) specifications to the DEF tank. Failure to comply may cause aftertreatment system damage.

 **NOTE**

Immediately wipe up spilled DEF with a clean cloth and water. If left to dry, DEF leaves a white residue that, when discovered, may suggest a leak in the DEF dosing system where no leak exists.

Before using containers, funnels, or other items used to dispense, handle, or store DEF, make sure to wash them thoroughly to remove any potential contaminants, and then rinse with distilled water.

 **NOTE**

Do not use tap water to rinse items that will be used to deliver diesel exhaust fluid (DEF). Tap water will contaminate the DEF, and could damage the after-treatment system.

**NOTE**

If distilled water is not available, rinse with tap water and then rinse with DEF.

DEF Disposal

If disposing Diesel Exhaust Fluid (DEF), always check with local authority regulations on proper disposal and requirements.

DEF Storage**NOTE**

The following information is for reference and is to be used as a guideline only. There are many factors that determine Diesel Exhaust Fluid (DEF) shelf life, with temperature and duration being two of the major determining contributors. If in doubt, replace the fluid with known quality DEF. DEF has a limited shelf life, both in the vehicle's diesel exhaust fluid tank and in storage/bulk/transportation containers.

The following conditions are ideal for maintaining Diesel Exhaust Fluid (DEF) quality and shelf life during prolonged transportation and storage:

- Storage temperature between 23°F and 77°F (-5°C and 25°C)
- Storage in sealed containers to avoid contamination
- Avoidance of direct sunlight

In these conditions, DEF has a minimum expected shelf life of 18 months. If stored at higher temperatures for an extended time, the shelf life will be reduced by approximately 6 months for every 9°F (5°C) above the highest storage temperature listed above. Long-term storage in a vehicle (more than 6 months) is not recommended.

**NOTE**

To assist in preventing DEF from deteriorating when stored in the vehicle's DEF tank, locate and plug the tank's venting to seal the tank exposure to the atmosphere.

DEF Quality**CAUTION**

Do NOT add water or any fluid other than DEF that meets ISO 22241-1 (DIN 70070) specifications to the DEF tank. Failure to comply may cause aftertreatment system damage.

The system monitors the Diesel Exhaust Fluid (DEF) quality under normal operating temperatures and when the vehicle is moving 8 kph (5 mph). In some situations, the system may not check DEF quality because of reduced operating temperatures. A service tool may be required to temporarily allow the system to check the DEF quality at operating temperatures regardless of vehicle speed.

Only DEF should be added to the DEF tank and should not be substituted with any other fluid, including but not limited to

- Water
- Diesel fuel
- Hydraulic fluid
- Coolant
- Windshield washer fluid

If a liquid other than DEF is added to the DEF tank, contact a PACCAR Authorized Repair location (see [Poor DEF Quality Actions](#) on page 23).

DEF Recommendations and Specifications

 **CAUTION**

It is unlawful to use diesel exhaust fluid (DEF) that does not meet the specifications provided or to operate the vehicle/equipment without DEF. Failure to comply may result in equipment or property damage.

 **WARNING**

Diesel Exhaust Fluid (DEF) contains urea. DO NOT get the substance in your eyes. In case of contact, immediately flush eyes with large amounts of water for a minimum of 15 minutes. DO NOT ingest. In the event the diesel exhaust fluid is ingested, contact a physician immediately. Reference the Materials Safety Data Sheet (MSDS)

for additional information. Failure to comply may result in personal injury.

 **CAUTION**

Do NOT attempt to create Diesel Exhaust Fluid (DEF) by mixing agricultural grade urea with water. Agricultural grade urea does not meet required specifications. Failure to comply may result in aftertreatment system damage.

 **CAUTION**

Only use diesel exhaust fluid (DEF) that meets ISO 22241-1 (DIN 70070) specifications. There is NO acceptable substitute. Failure to use the correct DEF may cause aftertreatment system damage and/or void the warranty.

PACCAR Inc. is not responsible for failures or damage resulting from what PACCAR Inc. determines to be abuse or neglect, including but not limited to: operation without correctly specified DEF; lack of maintenance of the engine aftertreatment

system; improper DEF storage, or shutdown practices; unauthorized modifications of the engine and engine aftertreatment system. PACCAR is also not responsible for failures caused by use of incorrect DEF or DEF containing water, dirt, or other contaminants. Refer to your engine and vehicle operator's manuals for maintenance and shutdown information. For engines using Selective Catalytic Reduction (SCR) operating in the United States and Canada, it is recommended that the DEF used be certified by the American Petroleum Institute (API).

 **NOTE**

To ensure the correct DEF is used, PACCAR Inc. recommends the use of TRP® CleanBlue Diesel Exhaust Fluid, which is available in different quantity options from small to bulk containers.



DEF Availability

- DEF is readily available at truck stops and at all PACCAR Engine dealers. For assistance locating DEF, contact your local PACCAR Authorized Repair location.
- For information on how to add DEF to the tank (see [Adding Diesel Exhaust Fluid \(DEF\)](#) on page 35).

Selective Catalytic Reduction (SCR) System

The SCR system reduces oxides of nitrogen (NOx) from the exhaust by mixing Diesel Exhaust Fluid (DEF) with a catalyst. The SCR system is composed of several main components:

- Heater Control Unit (HCU)¹
- DEF dosing unit (DEF Module)
- DEF dosing valve
- SCR catalyst
- AMOX section



CAUTION

It is unlawful to tamper with, modify, or remove any component of the SCR system. Failure to comply may result in equipment or property damage.



NOTE

Ultra-Low Sulfur Diesel (ULSD) fuel is required for engines equipped with an aftertreatment diesel particulate filter (DPF). If ULSD is not used, the engine may not meet emissions regulations; additionally, not using ULSD can damage the DPF or aftertreatment Diesel Oxidation Catalyst (DOC).

The system uses DEF from the DEF tank and delivers it to the DEF doser. The DEF doser sprays a small amount of DEF into the exhaust upstream of the SCR catalyst. The mixture of DEF and exhaust gasses form carbon dioxide and ammonia. The carbon dioxide and the ammonia enter the SCR catalyst and a chemical reaction is created in the presence of heat to convert the NOx into nitrogen and water vapor. Within the SCR catalyst housing, the Ammonia Oxidation Catalyst (AMOX section) removes any ammonia remaining from the NOx conversion process.

¹ MX-13 CARB engines only.

Heater Control Unit (HCU) MX-13 (CARB Only)

The Heater Control Unit (HCU) is used to meet CARB emission requirements and controls the compact twin canister heating unit.

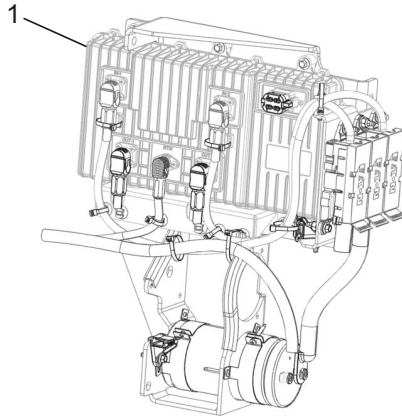

1. Heater Control Unit (HCU)

i NOTE

This HCU is only available on vehicles equipped with CARB Compliant PAC-CAR MX-13 engines and uses an 48 V system CARB architecture.

48 V Generator (CARB Only)

The 48 V generator supplies 48 V to the system and is located between the engine flywheel and the transmission clutch. This generator operates at a low temperature and has a dedicated cooling sub-system connected to the engine cooling system.

⚠ CAUTION

DO NOT use the 48 V cables or coolant lines attached to the 48 V generator as a support to perform an inspection or work under the vehicle. This will damage the cable connectors or coolant lines. Failure to comply may result in equipment or property damage.

2

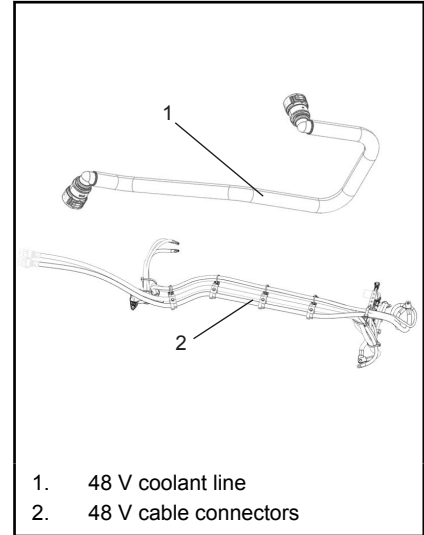

- 1. 48 V coolant line
- 2. 48 V cable connectors

This generator is only used on vehicles equipped with CARB Compliant PACCAR MX-13 CARB engines. The system operates during cold starts to bring the aftertreatment system up to operating temperature, leading to lower overall engine emissions. The Electronic Control Unit (ECU) controls the coolant pump and

2

maintains the generator to a temperature range below the standard engine coolant temperatures 104°F (40°C) and 240°F (116°C).

Chapter 3 | INDICATIONS AND CONTROLS

3

Diesel Exhaust Fluid (DEF) Level Gauge.....	23
Poor DEF Quality Actions.....	23
Warning Lights and Indicators.....	24
DPF Switches.....	30
Notifications.....	32

Diesel Exhaust Fluid (DEF) Level Gauge

The Diesel Exhaust Fluid (DEF) Level gauge shows the approximate amount of DEF in the DEF tank. The DEF Level gauge is located near the fuel gauge and is labeled with the DEF warning light:

DEF Warning Light



The DEF gauge is visible during all views and can differ according to model:

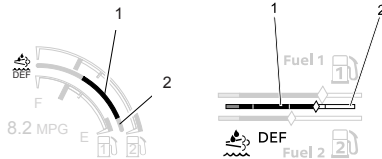

1. DEF amount
2. DEF level gauge

CAUTION

Only use Diesel Exhaust Fluid (DEF). Failure to do so may damage components of the diesel particulate filter (DPF).

DEF fluid is required to meet certain emission requirements. A warning icon and a notification will appear when the DEF level is low. Do not allow the DEF tank to remain empty.

Poor DEF Quality Actions

If a "Poor DEF Quality" condition occurs, there is a problem with the Diesel Exhaust Fluid (DEF). A poor DEF quality condition will also be accompanied by:

- DEF warning light
- Check engine light

And may be accompanied by



- Malfunction Indicator Light (MIL) (emergency vehicles only)

The DEF warning light state, and the actions taken by the EAS, will depend on how much time has passed since DEF quality was identified as poor.

Poor DEF Quality

	DEF Warning Light	Duration and Actions
1	RED	Initial detection No actions
2	RED	1 hr after initial 25% Derate ²

² Emergency vehicles are exempt from this derate.

	DEF Warning Light	Duration and Actions
3	 RED	3 hrs after initial 40% Derate ³
4	 RED	3 hrs after initial and any of the following: key cycle, refueled, or stopped for 1 hr. 40% Derate and 5 mph vehicle speed limit ⁴

A poor DEF quality condition will require the DEF tank to be drained, flushed, and refilled with new or known good-quality DEF. Following the initial notification, the operator has a period of time to address the issue before the first engine derate. The best response to a poor DEF quality condition will depend on vehicle location and the availability of facilities capable of

draining, flushing, and refilling the DEF tank.

- For questions regarding a poor DEF quality condition or to determine the appropriate repair direction, contact a local PACCAR Authorized Repair location, or call
 - 1-800-4PETERBILT (1-800-473-8372)**
 - 1-800-KW-ASSIST (1-800-592-7747)**



CAUTION

Do NOT add water or any fluid other than DEF that meets ISO 22241-1 (DIN 70070) specifications to the DEF tank. Failure to comply may cause aftertreatment system damage.

Warning Lights and Indicators

The instrument panel communicates many vehicle conditions using warning lights

(also called telltales), indicators, and audible alarms and tones. Alarms and tones are sometimes accompanied by an indicator or warning light. Some conditions are communicated for informational purposes only – indicators – while warning lights often require an operator response and are sometimes accompanied with a notification.

Warning lights, indicators, and audible alarms and tones may indicate a system malfunction or attempt to draw attention to the component it monitors, so they should be checked frequently and responded to promptly. These indications could save you from a serious accident.

Some of these indications also present an associated notification, providing additional information (see [Notifications](#) on page 32). Red and amber notifications are tallied at the top of the display and can be viewed in the notifications sub-menu when the parking brake is set. Additionally, gauges may become visible on the Digital Display and may change color or brightness to bring the gauge to the operator's attention.

³ Emergency vehicles are exempt from this derate.

⁴ Emergency vehicles are exempt from derate and speed limit.



WARNING



Do not ignore any type of tone or lights. These signals tell you that something is malfunctioning on your vehicle and provide you an indication

of what system is affected. It could be a failure of an important system, such as the brakes, which could lead to an accident and may result in property damage, personal injury, or death.



Some warnings can be managed by the operator while others may require an authorized dealer repair. The following

table lists the warning lights and indicators that appear on the instrument cluster. Each indication in this table has a unique name, symbol, and lists the illuminated color or colors. The table also lists whether the indication is standard (Std) or optional (Opt). Optional indications require the vehicle to have a specific component installed.

Indications

Indication Name	Symbol	Color	Standard	Option
<i>Diesel Particulate Filter (DPF)</i> on page 28		White Amber Red	•	
<i>Diesel Exhaust Fluid (DEF)</i> on page 26		Blue or Gray ⁵ White Red	•	
<i>Check Engine</i> on page 26		Amber	•	

⁵ Depending on model.

Indication Name	Symbol	Color	Standard	Option
<i>Stop Engine</i> on page 29		Red	•	
<i>High Exhaust System Temperature (HEST)</i> on page 29		Amber	•	
<i>Regeneration Required Exterior Notification (option)</i> on page 30	None	Sounds the city horn for ten seconds while flashing headlights		

Diesel Exhaust Fluid (DEF)

Check Engine



Turns on when a non-emissions-related problem exists, but the vehicle can still be safely driven. Vehicle should be serviced to correct the problem but the situation should not be considered an emergency.



The Diesel Exhaust Fluid (DEF) warning light is located next to (or below) the DEF gauge and is always visible. The DEF warning light will change color based on conditions specific to the DEF system and will be accompanied by a notification.

- These conditions include:
- Low DEF levels
 - Poor DEF quality
 - SCR system faults

DEF Warning Light States

State	Condition
Blue or Gray ⁶	Normal
White	Approaching low DEF level (stage 0)

⁶ Depending on model.

State	Condition
Red	Low DEF level (stage 1)
	Poor DEF quality (stage 1)
	SCR system fault (stage 1)
Flashing Red	Low DEF level (stage 2 – 4)
	Poor DEF quality (stage 2 – 4)
	SCR system fault (stage 2 – 4)

The specific condition responsible for the DEF warning light is explained on the notification accompanying the warning light; however, the operator can often confirm the condition using the gauges and indicators associated with the aftertreatment system. If the DEF warning light is red and the DEF level indicates full,

seek service immediately for DEF fluid quality or SCR System Fault. For help identifying the cause of the DEF warning light, see the quick reference tables at the end of this manual.

Low DEF Level

	NOTE
Failure to address and correct a low DEF level situation may cause the engine to derate and limit vehicle speed.	

If the DEF warning light is accompanied by a notification stating "Diesel Exhaust Fluid Low," then the amount of DEF available in the tank is low. This can result in an engine derate (see [Adding Diesel Exhaust Fluid \(DEF\)](#) on page 35).⁷

Poor DEF Quality

	CAUTION
Failure to address and correct a poor DEF quality situation may cause the engine to derate and limit vehicle speed. Poor DEF quality may cause damage to the DEF system.	

If the DEF warning light is accompanied by a notification stating "Poor DEF Quality," then DEF quality is below acceptable levels. This can result in an engine derate (see [Poor DEF Quality Actions](#) on page 23).⁸

SCR System Fault

	NOTE
Failure to address and correct an SCR System Fault may cause the engine to derate and limit vehicle speed.	

If the DEF warning light is accompanied by a notification stating "SCR System Fault"

⁷ Emergency vehicles are exempt from this derate.

⁸ Emergency vehicles are exempt from this derate.

or "SCR System Altered," this may be the result of a SCR component failure in the engine aftertreatment (DPF/SCR) system. This can result in an engine derate (see [SCR System Fault Actions](#) on page 44).⁹

Diesel Particulate Filter (DPF)

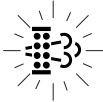

This warning means that the DPF needs to be regenerated and will appear when soot in the DPF exceeds an acceptable amount or a significant amount of hydrocarbons (HC) are detected.

DPF Warning Light States

State	Condition and Actions
White	Soot is above the acceptable amount.

State	Condition and Actions
	The DPF can be regenerated.
Amber	<p>Soot almost fills the DPF OR A significant amount of HC is detected in the DPF.</p> <p>The DPF should be regenerated to prevent derate. If due to HC, warning will be accompanied by a "DPF Warmup" notification (see DPF Warmup on page 41).</p>
Flashing Amber	<p>Soot has filled the DPF.</p> <p>The EAS will now derate the engine.¹⁰ A parked regeneration must be performed (see Stationary Regenerations on page 39).</p>
Flashing Red	<p>DPF is critically full.</p> <p>The EAS will further derate the engine.¹¹ The DPF can no longer be</p>

State	Condition and Actions
	regenerated and must now be removed and cleaned.

Each progressing stage is accompanied by an audible alert and a notification. Routine automatic regenerations are usually sufficient to eliminate the accumulated soot, but when the conditions for an automatic regeneration cannot be met, or there are high levels of soot in the DPF, a parked regeneration might be required (see Automatic Regeneration or Parked Regeneration). This warning may also appear if the system is attempting to regenerate automatically while the vehicle is in Power Take-off (PTO) mode.

⁹ Emergency vehicles are exempt from this derate.

¹⁰ Emergency vehicles are exempt from this derate.

¹¹ Emergency vehicles are exempt from this derate.

Stop Engine



This warning light appears with an audible alarm tone when the 48 V generator (MX-13 CARB engines only) has failed or when a major engine system problem exists.



WARNING

If the stop engine warning light turns on, a serious engine system problem has occurred. Safely stop the vehicle and turn OFF the ignition. Do not drive the vehicle until the vehicle has been serviced. Failure to comply may result in equipment damage, personal injury, or death.

High Exhaust System Temperature (HEST)



WARNING

If the High Exhaust System Temperature (HEST) warning light is on, do not park near people. The heat generated by the engine aftertreatment system (EAS) may cause serious burns if EAS components are contacted. Failure to do so may result in property damage, personal injury, or death.



WARNING

If the High Exhaust System Temperature (HEST) warning light is on, do not park near combustible vapors or materials. You must keep combustibles at least 5 ft. (1.5 m) away from the exhaust (outlet) stream as it exits the tail pipe while the HEST light is illuminated. Failure to do so could ignite an ex-

plosion and cause serious injury to bystanders.



WARNING

When the High Exhaust System Temperature (HEST) warning light is on, the temperature of the tailpipe, exhaust pipes, diesel particulate filter (DPF)/selective catalytic reduction (SCR) device, and surrounding components (including enclosures and steps) becomes elevated and can cause serious burns to the skin. Allow adequate cooling time before approaching, or working on or near, any part of the exhaust system or surrounding components. Failure to comply may result in death, personal injury, equipment damage or property damage.

The purpose of the High Exhaust System Temperature (HEST) warning light is to notify the operator to high temperatures in the vicinity of the tail pipe, diesel particulate filter (DPF), and surrounding components during a regeneration. The HEST warning light turns on only when the

vehicle is stationary or moving slowly: less than 5 mph (8 kph).

During a regeneration, some EAS components can reach temperatures greater than 1202°F (650°C). Therefore, it is important to pay attention to HEST warnings prior to, during, and immediately following a regeneration.

Regeneration Required Exterior Notification (option)

Vehicles built with controls for remote operation may be equipped with an Exterior Notification feature. This feature alerts a remote operator that the DPF should be regenerated.

When a heavily loaded DPF is detected, the EAS will sound the city horn for ten seconds while flashing the vehicle headlights. The exterior notification is accompanied by the usual, in-cab notifications that indicate when a regeneration is required. The engine may also derate based on the DPF condition (see DPF warning light). The ten-second, exterior notification can be acknowledged, silencing the alert, by

- Pressing the brake or clutch
- Turning off the engine
- Starting a parked regeneration

DPF Switches

Your vehicle may be equipped with a two or three-position DPF switch mounted on the dash.



WARNING

If you operate in an environment that contains explosive vapors or flammable materials, check if your vehicle's DPF switch is equipped with a **DISABLE** (or **STOP**) position. The DPF Switch must be placed in **DISABLE** (or **STOP**) prior to entering these environments to prevent automatic regenerations from occurring. Failure to place the DPF Switch in **DISABLE** (or **STOP**) before entering a combustible environment may cause a fire or explosion that could lead to death, personal injury, or equipment and property damage.



WARNING

Avoid operating the vehicle inside a building or in environments that con-

tain explosive vapors or flammable materials if your vehicle DPF Switch does not have a **DISABLE** (or **STOP**) position. If a **DISABLE** (or **STOP**) position is NOT present, and an active regeneration needs to be stopped, turn the vehicle ignition switch to **OFF** to temporarily stop the regeneration cycle. Failing to stop a regeneration cycle before entering a combustible environment may cause a fire or explosion that could lead to death, personal injury, equipment or property damage.



NOTE

Do not leave the switch in the **DISABLE** (or **STOP**) position unless you need to cancel or stop a regeneration. Running the engine with the switch in the **DISABLE** (or **STOP**) position will result in increased soot levels in the DPF, which could lead to an engine derate.

i NOTE

To obtain a DPF switch with a **STOP** position, contact a PACCAR Powertrain distributor to obtain the proper switch and to reprogram your engine's Electronic Control Unit (ECU).

Three-Position DPF Switch

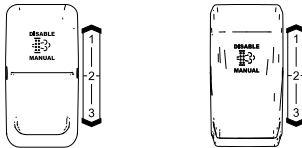

Positions:

1. **DISABLE**
2. Allow auto regeneration (center position)
3. **MANUAL** (temporary position)

DISABLE When **DISABLE** (1) is pressed, the system will not regenerate under any conditions.

i NOTE

Do not leave the switch in the **DISABLE** (or **STOP**) position unless you need to cancel or stop a regeneration. Running the engine with the switch in the **DISABLE** (or **STOP**) position will result in increased soot levels in the DPF, which could lead to an engine derate.

ALLOW AUTO REGENERATION This is the normal position (2) of the switch. Unless manually initiating a parked regeneration or intentionally stopping a regeneration, the switch should be in this position to allow automatic regenerations.

i NOTE

During normal vehicle driving, the regeneration switch must be in the **CENTER** position.

MANUAL Pressing the switch in the **MANUAL** direction (3) for at least 4 to 8 seconds will initiate a parked regeneration.

i NOTE

A parked regeneration requires your vehicle to be stopped with the parking brake set. (See [Stationary Regenerations](#) on page 39).

The three-position switch can initiate a parked regeneration, cancel a parked or automatic regeneration, or prevent an automatic regeneration from occurring.

One-Position DPF Switch (option)

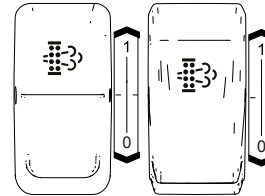

Positions:

1. **Start** (temporary position)

2. **Center** (resting position)

START Pressing the switch up (1) for at least 4 to 8 seconds starts a parked regeneration.¹²

Vehicles equipped with a two-position switch cannot use the switch to stop an automatic or parked regeneration.

Notifications

A notification communicates vehicle information. Notifications can be red, amber or white. Red and amber notifications are totaled in the Active Warnings Indicator at the top of the display. Notifications' characteristics (color, brilliance, and whether it flashes or has an audible alarm) depend on the condition that generated the notification.



1. System – Symbol representing affected system.
2. Title – Notification.
3. Suppressibility – Indicates if the current notification is suppressible using **Select**.
4. Stack Size – The lower number indicates how many notifications are in the stack (suppressible and non-suppressible), and the upper, which notification is being viewed.
5. Instructions – Contains instructions or elaborating information.

When multiple notifications are present, each is assigned a priority and placed in a stack. Higher priority notifications are placed towards the front of the stack. The **Select** button cycles through the active notifications, allowing each notification in the stack to be viewed. Some notifications, once viewed, are removed from the stack; these notifications are called suppressible. Suppressible notifications show an "X" below the **Select** icon and typically don't require an immediate response. Suppress these notifications using the **Back/Cancel** button

(or the **Select** when the parking brake is set). Non-suppressible notifications cannot be removed from the stack until the parking brake is set.



NOTE

The menu is not accessible until all notifications have been suppressed.¹³

¹² The requirements for a Parked Regeneration must first be met (see [Stationary Regenerations](#) on page 39).

¹³ All notifications become suppressible when the parking brake is set.

Chapter 4 | AFTERTREATMENT OPERATIONS

4

Adding Diesel Exhaust Fluid (DEF).....	35
City Delivery.....	35
Engine Aftertreatment System Power Requirements.....	36
Extended Idling.....	36
Regenerations.....	37
SCR System Fault Actions.....	44

Adding Diesel Exhaust Fluid (DEF)



WARNING

Diesel Exhaust Fluid (DEF) is corrosive. Avoid contact with eyes. If contact occurs, rinse eyes with large amounts of water for 15 minutes. Avoid prolonged or repeated contact with skin. In case of contact, immediately wash skin with soap and water. DO NOT consume DEF. If swallowed, seek immediate medical attention. DO NOT induce vomiting. Failure to comply may result in death or personal injury.



CAUTION

Diesel Exhaust Fluid (DEF) is corrosive. If DEF is spilled on metal surfaces (for example, the steps, fuel tanks, or grab handles), rinse and clean immediately with water. Failure to do so may leave permanent corrosive stains on the metal surfaces that cannot be removed.

- Avoid prolonged contact with skin. In case of contact, wash immediately with soap and water.
- Use only approved containers to transport and store DEF; polyethylene and polypropylene are recommended.
- If DEF is spilled, rinse and clean immediately with water. If not cleaned immediately, a white residue will remain when the DEF dries.



NOTE

Immediately wipe up spilled DEF with a clean cloth and water. If left to dry, DEF leaves a white residue that, when discovered, may suggest a leak in the DEF dosing system where no leak exists.

See your Chassis Operator's Manual for more information on adding DEF to the DEF tank. If your vehicle is out of DEF and you are unable to locate a source to purchase DEF, please contact the vehicle OEM customer care center at the

telephone number provided in the vehicle operator's manual. The vehicle OEM customer care center will contact the nearest dealer location and arrange for an emergency shipment of DEF to your location 24-hours a day.

City Delivery

The EAS may not be able to perform routine automatic regenerations of the DPF if the vehicle is normally driven at low speeds, or starts and stops frequently. When driving under these conditions, routine manual regenerations may need to be planned. Pay attention to the EAS warning lights and indicators to know when automatic regenerations are not being performed and plan accordingly.

Engine Aftertreatment System Power Requirements

CAUTION

Before disconnecting battery power, wait at least 20 minutes after the ignition switch is turned OFF. The engine aftertreatment system (EAS) uses battery power to circulate DEF and prevent overheating of the DEF system. Failure to comply may result in property damage.

For situations where the battery will be disconnected (for example, service or maintenance of the vehicle), please wait 20 minutes before disconnecting battery power.

Extended Idling

CAUTION

Prolonged periods of idling can result in lower than optimal engine/transmission operating temperatures, which can cause increased rates of wear. **Do not allow the engine to operate at idle for extended periods at temperatures at or below 160°F (71°C).** To help prevent this from occurring on PACCAR engines, an idle shutdown feature can be programmed to shut the engine down after a period of low idle operation with no driver activity. A flashing warning light will inform the driver of an impending shutdown. Failure to comply may result in equipment or property damage.

CAUTION

If the truck is equipped with Power Take-off (PTO) equipment, the engine shutdown system can be deactivated

when the PTO is operational; however, engine idle periods should not exceed five minutes whenever possible. Failure to comply may result in equipment or property damage.

In addition to wasting fuel, extended idle times (3 hours or more) can have an undesirable effect on the engine aftertreatment system, especially in cold weather.

The first effect is increased soot in the DPF system. This additional soot will accumulate in the DPF, requiring more frequent regenerations and may require performing a parked regeneration.

CAUTION

Do not ignore the diesel particulate filter (DPF) warning light. The warning light alerts the operator that the DPF should be regenerated. If soot is allowed to fill the DPF and a regeneration is not performed, the DPF will become clogged, requiring it to be removed and cleaned. Failure to comply may result in equipment or property damage.

The second effect is the accumulation of hydrocarbon (HC) deposits and moisture in the DPF. When large amounts of HC deposits accumulate, it will need to be removed prior to driving the vehicle. This requires a special type of parked regeneration: a DPF Warmup. When a DPF Warmup (also called a “desorb”) needs to be performed, the operator will receive a notification instructing (or requiring) that the DPF be warmed up prior to movement (see DPF Warmup). Because of fuel wastage and the potential “down time” spent performing DPF Warmups, long idle times should be avoided when possible. If an engine must idle for an extended period, idle the engine at the lowest rpm that maintains the engine coolant at 160°F (71°C), or above.

Regenerations

Soot, moisture, and fuel deposits will routinely need to be removed from the diesel particulate filter (DPF), with accumulated soot being burned off, leaving ash. The process for removing these materials is called regeneration (or a regeneration).

To “regenerate,” the DPF will need to be heated to a high temperature, which the

Engine Aftertreatment System (EAS) performs routinely using the hot exhaust gases generated during highway driving. This process is called a “passive regeneration” and should go unnoticed by the operator.

When passive regenerations are not sufficient, the EAS performs an active regeneration (or automatic regeneration). During an automatic regeneration, the engine increases the exhaust temperature and doses the exhaust with fuel to raise the temperature in the DPF to 1202°F (650°C). Automatic regenerations occur when the vehicle is moving and typically last 30 minutes.

The EAS may not be able to passively or automatically regenerate the DPF when the vehicle is driven at low speeds, starts and stops frequently, or the DPF has accumulated significant amounts of fuel or water. In such cases, warning lights and notifications will alert the operator, and a regeneration of the DPF may be required prior to driving the vehicle. This is called a parked regeneration (see [Stationary Regenerations](#) on page 39 and [DPF Warmup](#) on page 41).

Performing a Regeneration

When the DPF warning light is on, a regeneration of the DPF can be performed. Whether the DPF should be regenerated at the time the warning light appears or later is the decision of the operator. The operator should initiate a regeneration of the DPF based on the warning light color and the convenience of performing the regeneration.



CAUTION

Do not ignore the diesel particulate filter (DPF) warning light. The warning light alerts the operator that the DPF should be regenerated. If soot is allowed to fill the DPF and a regeneration is not performed, the DPF will become clogged, requiring it to be removed and cleaned. Failure to comply may result in equipment or property damage.

To prevent having to perform a parked regeneration, the DPF should be allowed to regenerate automatically. This could mean planning your route so that the conditions for an automatic regeneration

are satisfied (see [Automatic Regenerations](#) on page 38).

When the DPF warning light is white or amber, an automatic regeneration can be performed. If the conditions for an automatic regeneration cannot be supported, then the operator should plan to perform a parked regeneration before the warning light changes to flashing amber (see [Starting a Parked Regeneration](#) on page 40). When the warning light flashes amber, the check engine light turns on and the engine will derate, reducing vehicle speed and power.¹⁴



NOTE

If the DPF warning light is amber or a notification stating a DPF Warmup is occurring or is required, a special type of parked regeneration is needed (see [DPF Warmup](#) on page 41).

If the DPF warning light is flashing amber, a parked regeneration should be performed **as soon as possible** before the warning light turns red. When the DPF warning light is red, the vehicle must be

towed to a PACCAR Powertrain distributor to have the DPF either cleaned or replaced.

Automatic Regenerations

Automatic regenerations reduce the amount of soot, water, and fuel that accumulates in the DPF without resulting in vehicle “down time.” The Engine Aftertreatment System (EAS) attempts to perform an automatic regeneration when the DPF warning light is either white or amber, or when a significant amount of water or hydrocarbons (fuel and soot) are detected in the DPF. An automatic regeneration is the preferred regeneration method.

For an automatic regeneration to occur, the vehicle must maintain a minimum speed for the time needed to perform the regeneration. Highway driving conditions are usually sufficient to regenerate the DPF – a posted speed above 35 mph for about 30–45 minutes. Additionally, vehicles with a three-position DPF switch must not have the switch in the **DISABLE** (or **STOP**) position (see [DPF Switches](#) on page 30).

If the conditions for an automatic regeneration cannot be met, a parked regeneration will need to be performed (see [Stationary Regenerations](#) on page 39).



NOTE

If the High Exhaust System Temperature (HEST) warning light appears while the vehicle is stopping, then an automatic regeneration is in process. Understand the Warnings listed in the HEST topic prior to stopping the vehicle (see [High Exhaust System Temperature \(HEST\)](#) on page 29).

¹⁴ Emergency vehicles are exempt from this derate.

Enabling Automatic Regenerations



WARNING

Never allow an Automatic Regeneration to start while inside a building of any kind (for example, a service bay, or shop). Place the DPF Switch in **DISABLE** (or **STOP**) if your DPF switch is equipped with that position, prior to entering a building. A regeneration generates high temperatures that could ignite a fire or cause an explosion, resulting in property damage, personal injury, or death.

- If equipped with a three-position DPF switch, make sure it is not in the **DISABLE** (or **STOP**) position (see [DPF Switches](#) on page 30).
- Use an uncrowded highway with a posted speed of 35 mph or more.

When the DPF Warning light is on, the DPF can be regenerated. If you do not have a route with a highway, then plan to perform a parked regeneration ([Starting a Parked Regeneration](#) on page 40).

1. Maintain vehicle speed above 35 mph.
2. Try not to stop or idle the engine for 30-45 min.
3. When the DPF warning light turns off, the regeneration has completed.

Because EAS components can reach temperatures greater than 1202°F (650°C) while regenerating, pay attention to the warnings listed in ([High Exhaust System Temperature \(HEST\)](#) on page 29) immediately following a regeneration. If you have any problems or difficulties, contact your nearest PACCAR Powertrain distributor for assistance.

Stationary Regenerations

Some vehicle applications or situations might require performing a parked regeneration. This may occur when the conditions for an automatic regeneration could not be met, or long idle times have resulted in high levels of hydrocarbons (HC) in the diesel particulate filter (DPF). A regeneration that removes HC from the DPF is called a DPF warmup (see [DPF Warmup](#) on page 41) and is also called a

"HC desorb." Parked regenerations require the vehicle to remain stationary.¹⁵ Because of the high EAS temperatures required for a regeneration, important precautions must be followed prior to starting a parked regeneration:

- Park in a safe location.
- Ensure no one is near the tail pipe.
- Ensure there are no combustible materials within 5 ft. (1.5m) of the vehicle.
- Ensure there are no combustible vapors in the vicinity of the vehicle.
- Never initiate in a building or enclosure.

Read the warnings listed in [Starting a Parked Regeneration](#) on page 40 prior to performing a parked regeneration.

It is the operator's responsibility to take the necessary precautions and ensure that no combustibles (materials or vapors) or bystanders are close by before starting a regeneration.

A parked regeneration can only be started manually (see [DPF Switches](#), and [Starting a Parked Regeneration](#) on page 40).

During a parked regeneration, engine rpm

¹⁵ Certain PTO options allow the vehicle to be moving.

increases noticeably (1100 rpm) and the HEST warning light will turn on. Vehicles equipped for remote operation (PTO) may also need to be regenerated when operated remotely. The optional feature, regeneration required exterior notification, can alert a remote operator when the DPF needs to be regenerated (see [Regeneration Required Exterior Notification \(option\)](#) on page 30).

Starting a Parked Regeneration



WARNING

Do NOT initiate a parked regeneration in a closed building or enclosure. Always park your vehicle outside and ensure no one is in the immediate vicinity. Failure to comply could ignite a fire or cause an explosion, resulting in death, personal injury, or damage to equipment or property.



WARNING

Parking the vehicle too close to any combustible materials or vapors may start a fire, ignite an explosion or burn someone standing close by. Before pushing the DPF Switch on the dash, walk around your vehicle and ensure you have at least 5 ft. (1.5 m) clearance from the sides and top of your vehicle to any combustibles. Ensure no one is in the immediate vicinity of the tail pipe. Failure to comply could ignite a fire or cause an explosion, resulting in death, personal injury, equipment or property damage.

1. Pull the vehicle over to a safe location.
2. Walk around the vehicle and ensure no one is in the immediate vicinity of the tail pipe, and that there is a minimum 5 ft clearance between the vehicle and any combustible materials.



NOTE

Typical operation areas or materials that can contain explosive vapors, flammable materials or people in close proximity of the vehicle are:

- Fuel depots
- Grain elevators
- Dry grass, leaves or trees
- Transfer refuse stations/ dumps
- Parking lots
- Load/unload terminals

While the list above may appear comprehensive, it is your responsibility to take the necessary precautions and be aware of your surroundings and ensure that no combustibles (materials or vapors) or bystanders are close by before initiating a regeneration.

3. Verify that the following conditions exist before proceeding:
 - Parking brake is set
 - DPF warning light is on or flashing

- Coolant is at operating temperature
 - Neither the throttle, brake, or clutch is applied
 - PTO is disengaged ¹⁶
 - Transmission is in Neutral (**N**) or Park (**P**)
 - Cruise control switch is **OFF**
4. Climb back into the vehicle.
 5. Press **MANUAL** (or **START**) on the DPF switch for 4 to 8 seconds to initiate a parked regeneration.

to verify that all system requirements have been met.

6. After a successful regeneration, the following warning lights will turn off:
 - DPF warning light
 - Check engine light (if on)
 - HEST warning light (after the EAS cools down)

The regeneration will automatically shut off if any of the conditions in step 3 change or become activated. Contact your nearest PACCAR dealer for assistance if you are unable to initiate a parked regeneration and the DPF warning light is on.

regeneration are not required. A DPF warmup is also called a “desorb.”



CAUTION

Do not ignore prompts requiring a DPF warmup. Accumulated hydrocarbons in the Engine Aftertreatment System (EAS) can damage the EAS, degrading its performance. Failure to Warmup the DPF before driving, when required, can result in damage to the EAS, potentially calling for its replacement.



NOTE

Verification that a parked regeneration has initiated will vary by engine. The most common indication will be an increase in engine rpm and overall engine noise.



NOTE

A parked regeneration may take 30 or more seconds to initiate as the after-treatment system conducts self-checks

DPF Warmup

A DPF warmup is a special parked regeneration used to removed hydrocarbons (fuel) and moisture that can collect in the diesel particulate filter (DPF). Unlike a standard parked regeneration, a DPF warmup can activate automatically during engine start if a significant amount of hydrocarbons (HC) are detected; further, the DPF system doesn't get as hot during a DPF warmup, so the precautions normally taken before a standard parked

¹⁶ Parked regeneration with PTO engaged is dependent on vehicle configuration.

When there is a significant amount of HC in the DPF, one of two notifications will appear, alerting the operator:

Stage 1: Stationary

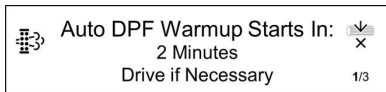

Stage 2 and 3: Stationary or Moving

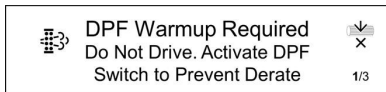

The DPF warning light may or may not be on when a DPF warmup notification occurs.

There are three stages of concern when hydrocarbons are detected in the DPF. Each stage presents the operator with indications informing to the amount of HC detected in the DPF, and corresponds with recommended actions, and at some stages, vehicle limitations.

First Stage (Occurs When Stationary)

Warnings	Vehicle Actions
Notification: Auto DPF Warmup	Automatic Regen <i>Regen is not required, and may be postponed</i>

Second Stage

Warnings	Vehicle Actions
Notification: DPF Warmup Required	Manual Regen Required
DPF warning light: amber	Do Not Drive
Check Engine Light	Engine Derates
Stop Engine Light (if moving)	
Audible Alert (if moving)	

Third Stage

Warnings	Vehicle Actions
Notification: DPF Warmup Required	Manual Regen Required
DPF warning light: amber	Do Not Drive
Stop Engine Light (if moving)	Engine Derates (50%)
Audible Alert (if moving)	

When moderate amounts of HC are detected (stage 1), a DPF warmup occurs automatically once the vehicle is parked – warning the driver first with a two-minute countdown. When larger amounts are detected (stages 2 and 3), a regeneration must be performed manually (see [Stationary Regenerations](#) on page 39). The vehicle must remain stationary during a warmup, but can be canceled in the same way as a parked regeneration:

- Service brake
- Accelerator pedal
- Clutch

- DPF Switch in **DISABLE** (or **STOP**).¹⁷



NOTE

If you do not initiate a parked regeneration upon receiving the **DPF Warmup Required** notification and continue to drive the vehicle, the Stop Engine Light will eventually turn on and engine power will derate.

During the warmup, engine rpm will increase, where it will remain for 20 to 60 minutes; but the DPF system will not get hot enough for the High Exhaust System Temperature (HEST) warning light to turn on.

Stopping a Regeneration



WARNING

Avoid operating the vehicle inside a building or in environments that contain explosive vapors or flammable materials if your vehicle DPF Switch

does not have a **DISABLE** (or **STOP**) position. If a **DISABLE** (or **STOP**) position is NOT present, and an active regeneration needs to be stopped, turn the vehicle ignition switch to **OFF** to temporarily stop the regeneration cycle. Failing to stop a regeneration cycle before entering a combustible environment may cause a fire or explosion that could lead to death, personal injury, equipment or property damage.



WARNING

If you operate in an environment that contains explosive vapors or flammable materials, check if your vehicle's DPF switch is equipped with a **DISABLE** (or **STOP**) position. The DPF Switch must be placed in **DISABLE** (or **STOP**) prior to entering these environments to prevent automatic regenerations from occurring. Failure to place the DPF Switch in **DISABLE** (or **STOP**) before entering a combustible environment may cause a fire or explosion that could lead to death, per-

sonal injury, or equipment and property damage.



NOTE

To obtain a DPF switch with a **STOP** position, contact a PACCAR Powertrain distributor to obtain the proper switch and to reprogram your engine's Electronic Control Unit (ECU).

A parked regeneration can be canceled by:

- Stopping the engine
- Selecting **DISABLE** (or **STOP**) on a three-position, DPF switch
- Pressing the accelerator pedal
- Pressing the clutch
- Pressing the service brake

An automatic regeneration can only be canceled by:

- Idling the engine
- Stopping the engine
- Selecting **DISABLE** (or **STOP**) on a three-position, DPF switch

If an automatic regeneration is canceled, the EAS will attempt to perform another

¹⁷ Three-position DPF switch only.



automatic regeneration ten minutes later, assuming the canceling criteria is no longer applicable.

SCR System Fault Actions

The selective catalytic reduction (SCR) system detects failures that may be the result of a SCR component failure in the engine aftertreatment system (EAS). The SCR system fault condition will also be accompanied by

- DEF warning light
- Check Engine light
- Malfunction Indicator Light (MIL)

SCR System Fault

	DEF Warning Light	Duration and Actions
1	 RED	Initial detection No actions
2	 RED	1 hr after initial 25% Derate ¹⁸
3	 RED	4 hr after initial 40% Derate ¹⁹

	DEF Warning Light	Duration and Actions
4	 RED	4 hr after initial and any of the following: key cycle, refueled, or stopped for 1hr. 40% Derate and 5 mph vehicle speed limit ²⁰

The DEF warning light state and the actions taken by the EAS will depend on the time elapsed since the SCR system fault was first identified. If a SCR system fault condition occurs, the SCR system will need to be inspected and repaired. The best operator response to a SCR system fault will depend on vehicle location and the availability of facilities capable of locating and addressing the reason for the fault.

1. For questions regarding a SCR system fault or to determine an appropriate repair direction, contact

¹⁸ Emergency vehicles are exempt from this derate.

¹⁹ Emergency vehicles are exempt from this derate.

²⁰ Emergency vehicles are exempt from derate and speed limit.

a local PACCAR Authorized Repair
location, or call

- **1-800-4PETERBILT**
(1-800-473-8372)
- **1-800-KW-ASSIST**
(1-800-592-7747)

Chapter 5 | MAINTENANCE

Preventive Maintenance.....	47
Diesel Particulate Filter (DPF) Service Strategy.....	49
Use Category Definitions.....	49
Preventive Maintenance Schedule.....	49
Diesel Exhaust Fluid (DEF) Filter Access.....	53
DEF Pump Filter Replacement.....	53
DEF Coolant Filter Cleaning.....	56
Replacing Emissions Related Parts.....	58
Diesel Exhaust Fluid (DEF) Tank.....	58

Preventive Maintenance

Preventive maintenance begins with the daily checks listed in your vehicle operator's manual. Routine vehicle checks can help avoid many large, expensive, and time consuming repairs, and will contribute to better, safer, and longer vehicle operation. Neglect of recommended maintenance can void your vehicle's warranty. Some maintenance operations demand skills and equipment you may not have. For such situations, please take your vehicle to an authorized PACCAR Service Center.

 WARNING
Always move the vehicle off-road to a safe location for servicing. Failure to comply may result in death, personal injury, equipment damage, or property damage.

 WARNING
Before attempting any procedure in the engine compartment, stop the en-

gine and let it cool down. Hot fluids and components can burn skin on contact. Failure to comply may result in death, personal injury, equipment damage, or property damage.

 WARNING
If the engine must be running to inspect, be alert and cautious around the engine at all times. Failure to comply may result in death, personal injury, equipment or property damage.

 WARNING
If work must be done with the engine running, always: <ul style="list-style-type: none"> • Ensure that the transmission is in neutral (N) or park (P) • Set the parking brake • Block the wheels Failure to comply may result in death, personal injury, equipment or property damage.

 WARNING
DO NOT wear neckties, jewelry, and/or loose clothing, and secure long hair to avoid getting caught in the fan blades or other moving engine parts. Failure to comply may result in death, personal injury, equipment damage, or property damage.

 WARNING
Always support the vehicle with appropriate safety stands if it is necessary to work underneath the vehicle. A jack is not adequate for this purpose. Failure to comply may result in death, personal injury, equipment or property damage.



WARNING

When working underneath the vehicle with the wheels on the ground (not supported), make sure that

- The vehicle is on hard, level ground.
- The parking brake is applied.
- All wheels are blocked (front and rear).
- The ignition key is removed to prevent the engine from starting.

Failure to comply may result in death, personal injury, equipment damage or property damage.



WARNING

NEVER start or let the engine run in an enclosed, unventilated area. Engine exhaust fumes contain carbon monoxide, a colorless and odorless gas. Carbon monoxide can be fatal if inhaled. Failure to comply may result in property damage, personal injury, or death.

For towing the vehicle, please follow the safety procedures below:



WARNING

Refer to the towing procedure training on PACCAR.net for lifting points on vehicle restrictions, power disconnection instructions, driveline removals, and e-Axles disengages Failure to comply may result in death, personal injury, equipment or property damage.

The tables on the following pages contain maintenance tasks. These tasks should be performed at the interval labeled at the top of the table, which are based either on vehicle mileage, or vehicle mileage and time passed since the last time that task was performed. Some tasks depend on vehicle application -- or how and where the vehicle is operated. These tasks will have the words ON-HIGHWAY, OFF-HIGHWAY, CITY DELIVERY, or VOCATIONAL after the description and should be performed if the vehicle is operated for that application:

- ON-HIGHWAY – Applications where the vehicle is only used on paved roads during normal operation.

- OFF-HIGHWAY – Applications where the vehicle may be driven off the pavement on a regular basis, even if it is an infrequent basis and/or for a brief time period.
- CITY DELIVERY – Applications where frequent start and stopping is required during normal operation, and highway use is infrequent and for short intervals.
- VOCATIONAL – Applications based on truck configuration and use and not on operating environment. Vocational vehicle components must meet the requirements needed for its specific application (such as delivery, construction, fire service, refuse, and busing). A truck can be Vocational in addition to other application types. Vehicles that fall into more than one application category should observe the earliest and more limiting application's maintenance requirements.

If there are questions regarding which intervals to follow, please contact an authorized PACCAR Service Center. Consult the supplier for specific recommendations where discrepancies

develop between the recommendations in the following maintenance tables and the component supplier recommendations.

Diesel Particulate Filter (DPF) Service Strategy

There are two DPF service strategies:

- Dry cleaning
- DPF replacement

	NOTE
<p>The DPF cleaning intervals are based on the use of lubricating oils that meet the SAE 10W-30 API CK-4/FA-4 oil specification.</p>	

Dry Cleaning

The dry cleaning strategy (using an FSX or equivalent machine) uses high pressure air and/or heat to remove impacted ash from the filter media. Dry cleaning can be performed at a PACCAR Powertrain

distributor. A filter that has been cleaned using a method other than the prescribed dry cleaning will need to be replaced.

DPF Replacement

If the DPF has been compromised, the DPF element will need to be replaced with new parts.

Use Category Definitions

Be aware that it's possible for your vehicle to fall into more than one use-category. Always use the most restrictive of two possible maintenance intervals for a given task.

When referring to your maintenance schedule, know your use-categories and refer to ALL that are applicable to your vehicle.

NORMAL DUTY LINE HAUL (Two categories >20% idle time <20% idle time. Note that each has unique maintenance scheduling):

- Fuel economy greater than 6 mpg (2.6 km/l).

- Gross vehicle weight less than 80,000 lbs/36,300 kg.

PICKUP/DELIVERY/REFUSE

- Fuel economy less than 6 mpg (2.6 km/l).
- Gross vehicle weight more than 80,000 lbs/36,300 kg.

SEVERE DUTY/VOCATIONAL

- Fuel economy less than 6 mpg (2.6 km/l).
- Gross vehicle weight more than 80,000 lbs/36,300 kg.
- Vocational vehicle applications include: agriculture, concrete mixers, construction, cranes, dumps, emergency/fire, heavy equipment, loggers, mining, oil field, snowplows and wreckers.

Preventive Maintenance Schedule

Heavy Duty and Low Cab Forward

At first 15,000 mi / 24,000 km or at first PM

Cooling - DEF Coolant Filter

- Check and clean strainer. (Refer to [DEF Coolant Filter Cleaning](#) on page 56 for maintenance instructions.)

Every 120,000 mi / 192,000 km / Annually

Cooling - DEF Coolant Filter

- Check and clean strainer. (Refer to [DEF Coolant Filter Cleaning](#) on page 56 for maintenance instructions.)

5

Medium Duty

Every 15,000 mi / 24,000 km / Annually

Cooling - DEF Coolant Filter

- Check and clean strainer. (Refer to [DEF Coolant Filter Cleaning](#) on page 56 for maintenance instructions.)

Normal Duty/Line Haul

Interval A – Normal Duty/Line Haul – Every 150,000 mi / 240,000 km / 4,500 hrs / 2 years

Every 150,000 mi / 240,000 km / 4,500 hrs / 2 years

Aftertreatment System

- Refer to [Diesel Particulate Filter \(DPF\) Service Strategy](#) on page 49 for maintenance instructions.

Interval B – Less than 20% Idle Time – Every 300,000 mi / 480,000 km / 6,750 hrs / 3 years

Every 300,000 mi / 480,000 km / 6,750 hrs / 3 years

Aftertreatment System

- Refer to [Diesel Exhaust Fluid \(DEF\) Filter Access](#) on page 53 for maintenance instructions.

Interval C – Greater than 20% Idle Time – Every 300,000 mi / 480,000 km / 6,750 hrs / 3 years

Every 300,000 mi / 480,000 km / 6,750 hrs / 3 years

Aftertreatment System

- Refer to [Diesel Exhaust Fluid \(DEF\) Filter Access](#) on page 53 for maintenance instructions.

Severe Duty/Vocational

Interval A – Severe Duty/Vocational – Every 150,000 mi / 240,000 km / 4,500 hrs / 2 years

Every 150,000 mi / 240,000 km / 4,500 hrs / 2 years

Aftertreatment System

- Refer to [Diesel Particulate Filter \(DPF\) Service Strategy](#) on page 49 for maintenance instructions.

Interval B – Severe Duty/Vocational – Every 300,000 mi / 480,000 km / 9,000 hrs / 3 years

Every 300,000 mi / 480,000 km / 9,000 hrs / 3 years

Aftertreatment System

- Refer to [Diesel Exhaust Fluid \(DEF\) Filter Access](#) on page 53 for maintenance instructions.

Pick-up/Delivery/Refuse

Interval A – Pick-up/Delivery/Refuse – Every 150,000 mi / 240,000 km / 4,500 hrs / 2 years

Every 150,000 mi / 240,000 km / 4,500 hrs / 2 years

Aftertreatment System

- Refer to [Diesel Particulate Filter \(DPF\) Service Strategy](#) on page 49 for maintenance instructions.

Interval B – Pick-up/Delivery/Refuse – Every 300,000 mi / 480,000 km / 9,000 hrs / 3 years

Every 300,000 mi / 480,000 km / 9,000 hrs / 3 years

Aftertreatment System

- Refer to [Diesel Exhaust Fluid \(DEF\) Filter Access](#) on page 53 for maintenance instructions.

Diesel Exhaust Fluid (DEF) Filter Access

Perform these maintenance procedures according to the preventive maintenance schedule.

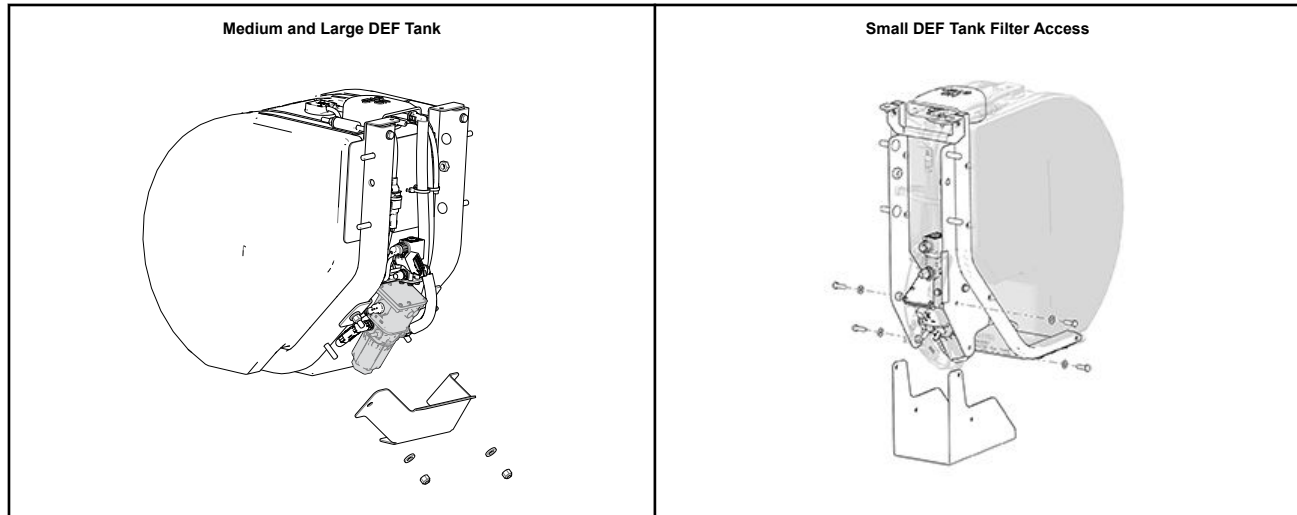

1. From the bottom of the tank, remove the cover plate by removing the fasteners attached to the cover plate, then allow the cover plate to drop down.
2. Replace the aftertreatment DEF dosing unit (DEF module) filter (refer to [DEF Pump Filter Replacement](#) on page 53).

DEF Pump Filter Replacement

5

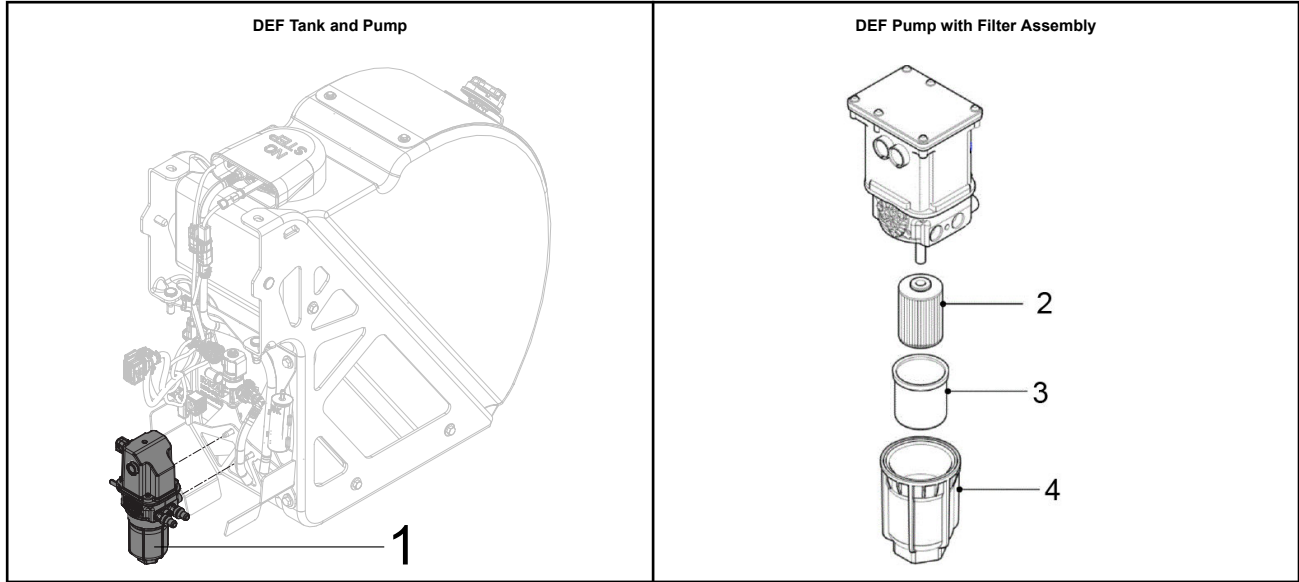

The following items are required for this procedure:

- Filter element with O-ring (kit)
- Two dry, clean, lint-free cloths
- New DEF (for lubrication)
- 1 13/16 in socket with 3/4-inch drive ratchet
- Container (1-liter capacity)
- Mild detergent and water
- Torque wrench with 59 lb-ft (80 N•m) capacity



WARNING

Diesel Exhaust Fluid (DEF) is corrosive. Avoid contact with eyes. If contact occurs, rinse eyes with large amounts of water for 15 minutes. Avoid prolonged or repeated contact with skin. In case of contact, immediately wash skin with soap and water. DO NOT consume DEF. If swallowed, seek immediate medical attention. DO NOT induce vomiting. Failure to comply may result in death or personal injury.



CAUTION

Before disconnecting battery power, wait at least 20 minutes after the ignition switch is turned OFF. The engine aftertreatment system (EAS) uses battery power to circulate DEF and prevent overheating of the DEF system. Failure to comply may result in property damage.



NOTE

Never operate the vehicle with the DEF filter or filter housing removed.



NOTE

Do not use tap water to rinse items that will be used to deliver diesel exhaust fluid (DEF). Tap water will contaminate the DEF, and could damage the after-treatment system.



NOTE

If distilled water is not available, rinse with tap water and then rinse with DEF.

Perform this procedure at least 20 minutes after the engine has been shut down. After 20 minutes has elapsed, disconnect the batteries. Inspect the area around the seal and filter housing for white deposits, indicating possible DEF leakage. If deposits are found, check DEF pump threads for damage once the filter housing

is removed. Replace entire DEF pump if the threads are damaged.

1. Place container beneath the DEF pump (1) to collect residual DEF.
2. Using a 1 13/16 in socket, loosen and remove filter housing (4), and dispose of O-ring. Set filter housing aside.



NOTE

Ensure dirt or foreign objects do not enter the pump. Even a small amount of dirt or debris can cause permanent damage to the DEF dosing system.

3. Remove and dispose of frost protection membrane (3). Be careful not to spill remaining DEF when removing.
4. Twist and pull the filter element out of the pump (2), and dispose filter element.



CAUTION

If there is a possibility that contaminated DEF has passed through the dosing system, visually check the filter element for evidence of contaminated DEF (specks of discoloration), or change in aroma, prior to disposal. If debris is evident on the filter element, also check the DEF tank filter and pump inlet connector. Contaminated DEF must be disposed of properly. Contact your nearest PACCAR dealer for assistance. Failure to comply may result in equipment or property damage.

Absorb dripping DEF with a lint-free cloth.

5. Inspect the pump for cracks, holes, or damaged threads. If pump or pump threads are damaged, replace the entire DEF pump.
6. Clean the pump and frost protection membrane groove with distilled water and a clean cloth.
7. Slide the new filter element into the pump until it clicks.



NOTE

Confirm filter element is correctly seated in pump; otherwise, DEF system damage will occur.

8. Install new frost protection membrane over filter element.



NOTE

The sealing bead of the membrane must sit completely within the frost protection membrane groove of the pump.

9. Apply DEF to lubricate the following:
 - Pump threads
 - Frost membrane sealing bead
 - New O-ring



NOTE

Only use DEF to lubricate. The use of any other lubricant can cause damage.

10. Install lubricated O-ring, then install and tighten filter housing to 59 lb-ft (80 N•m) using a 1 13/16 in socket.

Reconnect the batteries. Start the engine (turning ignition switch through **ON** primes pump) and check for leaks. Dispose of DEF and DEF contaminated components properly.

DEF Coolant Filter Cleaning

DEF Coolant Filter

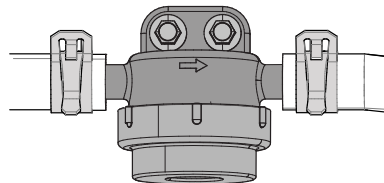

For most models, the DEF coolant filter is mounted inside the right-hand rail, forward of the back-of-cab crossmember; however, for low cab forward (LCF) models, it is

mounted to the back-of cab vertical stanchion, inboard of the DEF tank.

 **WARNING**

Diesel Exhaust Fluid (DEF) is corrosive. Avoid contact with eyes. If contact occurs, rinse eyes with large amounts of water for 15 minutes. Avoid prolonged or repeated contact with skin. In case of contact, immediately wash skin with soap and water. DO NOT consume DEF. If swallowed, seek immediate medical attention. DO NOT induce vomiting. Failure to comply may result in death or personal injury.

 **WARNING**

Do not work on the vehicle immediately after operation. Working on a hot vehicle component could result in serious injury or death.

Required tools:

- 2 hose pinch-off pliers
- Soft nylon brush
- Distilled water

- Container (minimum 16 oz)
 - New 44mm x 1.5 mm O-ring
- Perform this maintenance with the engine cold and coolant system depressurized.
1. Push back convoluted-hose covering, if present, to expose hose.
 2. Using hose pinch-off pliers, pinch and lock pliers on both the inlet and outlet hoses to the filter, stopping flow to filter.

 **CAUTION**

Use pliers that will not damage the hose. Failure to comply may cause a coolant leak, resulting in damage to vehicle components.

3. Place container under the filter.
4. Wearing gloves, turn and remove filter cap and set cap aside. *Some liquid will spill from filter housing and cap.*
5. Remove screen and O-ring from filter body and dispose of O-ring.
6. Clean screen with a soft nylon brush, removing any particulate. Then, rinse screen and interior of

- filter body and cap with distilled water.
7. Reinsert screen with new O-ring, and then reattach filter cap, hand-tight.
8. Detach pliers from hoses and dispose of captured coolant properly.

 **NOTE**

Coolant is harmful to the environment. Unused coolant must be stored as a toxic hazardous material in leak-proof containers. Used coolant must be processed as industrial chemical waste. Please follow HAZMAT guidelines with both used and unused coolants.

9. Verify coolant surge tank for proper coolant level and add coolant if necessary (see Inspect Coolant Level and How to Add Coolant to the Coolant System, located in your vehicle operator's manual).
10. Start the engine and run at idle speed for several minutes. Check for leaks and coolant level again.

Replacing Emissions Related Parts

PACCAR recommends that any service parts used for maintenance, repair, or replacement of emission control systems be new or genuine-approved rebuilt parts and assemblies, and that the vehicle be serviced by an authorized PACCAR Powertrain distributor. Your vehicle contains air, fuel, and electrical components that may affect engine emission controls. The use of non-genuine aftermarket parts, auxiliary devices or consumables (such as filters, oils, catalysts, additives, and fuels) may result in failures, which will not be covered under the manufacturer's warranty. PACCAR does not evaluate all aftermarket auxiliary devices, accessories or consumables promoted by other manufacturers and their effect on PACCAR Products. Customers who use such items assume ALL risks related to the effects that result from this usage.





Diesel Exhaust Fluid (DEF) Tank



Inspect the tank, straps, brackets, hoses and fittings for abrasion damage, leaks, tightness and fully engaged connectors.

Chapter 6 | QUICK REFERENCE TABLES

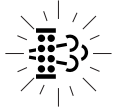
Warning Symbols Quick Reference.....	61
DEF Quality Warning – Non-Emergency Vehicles.....	62
DEF Quality Warning – Emergency Vehicles.....	63
DEF Level Warning – Non-Emergency Vehicles.....	65
DEF Level Warning – Emergency Vehicles.....	66
SCR System Fault Warning – Non-Emergency Vehicles.....	67
SCR System Fault Warning – Emergency Vehicles.....	69
DPF Regeneration Required Notification.....	70
High Exhaust System Temperature (HEST) Notification.....	71

Warning Symbols Quick Reference

FOR INFORMATION		SEEK SERVICE		TAKE IMMEDIATE ACTION	
	Hot Exhaust - Stay Clear		Check Engine		Coolant Temperature Stop vehicle and idle engine.
	Regenerate DPF		Engine - Emissions		

FOR INFORMATION		SEEK SERVICE		TAKE IMMEDIATE ACTION	
	See warning light <i>Diesel Exhaust Fluid (DEF)</i> on page 26.			 1 2	Stop the engine or the engine may automatically shutdown. ²²
Stop Engine ²¹					
These icons may appear alone or together to alert of necessary action to be taken as soon as possible. Warnings may be either tell-tales or lights within the gauge associated with that fluid. These warning lights will start flashing to notify of an upcoming engine derate.					

6

DEF Quality Warning – Non-Emergency Vehicles









Some vehicles may have a notification/information screen in addition to these icons. Additional messages may appear in your information center of the instrument cluster.

The DEF warning light described in this table only applies to vehicles powered by PACCAR MX Engines.

Stage	Warning Lights \ Indicators			Condition	Effect
	DEF	Check Engine	Stop Engine		
0	OFF			No DEF quality issue	None

²¹ Either symbol 1 or 2 will appear depending on engine make for the vehicle.



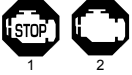



²² May not apply for fire or emergency vehicle applications.

Stage	Warning Lights \ Indicators			Condition	Effect
	DEF	Check Engine	Stop Engine		
1	 RED		OFF	Quality issue detected	None
2	 RED		OFF	1 hr after detected	25% derate
3	 RED		OFF	3 hrs after detected	40% derate
4	 RED		 1 2 May be ON	3 hrs after detected <i>and</i> any of the following: key cycle, refueled, or parked for 1hr.	40% derate and max vehicle speed 5 mph

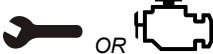
DEF Quality Warning – Emergency Vehicles

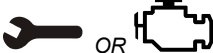
Some vehicles may have a notification/information screen in addition to these icons. Additional messages may appear in your information center of the instrument cluster.





The DEF warning light described in this table only applies to vehicles powered by PACCAR MX Engines.



Stage	Warning Lights \ Indicators			Condition	Effect
	DEF	Check Engine or MIL ²³	Stop Engine		
0	OFF			No DEF quality issue	None
1			OFF	Quality issue detected	None
2			OFF	1 hr after detected	None
3			OFF	3 hrs after detected	None
4			OFF	3 hrs after detected <i>and</i> any of the following: key cycle, refueled, or parked for 1hr.	None

²³ Depends on fault.

DEF Level Warning – Non-Emergency Vehicles

Some vehicles may have a notification/information screen in addition to these icons. Additional messages may appear in your information center of the instrument cluster.



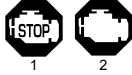



Stage	Warning Lights \ Indicators			Condition	Effect
	DEF	Check Engine	Stop Engine		
0	OFF			Sufficient DEF	None
1	 RED	OFF		Low DEF in tank	None
2	 RED		OFF	DEF tank almost empty	25% derate
3	 RED		OFF	DEF tank empty	40% derate

Stage	Warning Lights \ Indicators			Condition	Effect
	DEF	Check Engine	Stop Engine		
4	 RED		 May be On	DEF tank empty <i>and</i> any of the following: key cycle, refueled, or parked for 1 hr.	40% derate and max vehicle speed 5 mph

DEF Level Warning – Emergency Vehicles

Some vehicles may have a notification/information screen in addition to these icons. Additional messages may appear in your information center of the instrument cluster.

Stage	Warning Lights \ Indicators			Condition	Effect
	DEF	Check Engine	Stop Engine		
0	OFF			Sufficient DEF	None
1	 RED	OFF	OFF	Low DEF in tank	None

Stage	Warning Lights \ Indicators			Condition	Effect
	DEF	Check Engine	Stop Engine		
2	 RED		OFF	DEF tank almost empty	None
3	 RED		OFF	DEF tank empty	None
4	 RED		OFF	DEF tank empty <i>and</i> any of the following: key cycle, refueled, or parked for 1 hr.	None











SCR System Fault Warning – Non-Emergency Vehicles

Some vehicles may have a notification/information screen in addition to these icons.

Additional messages may appear in your information center of the instrument cluster.

The DEF warning lamp described in this table only applies to vehicles powered by PACCAR MX engines.









QUICK REFERENCE TABLES - SCR System Fault Warning – Non-Emergency Vehicles

Gauge	Warning Lights \ Indicators			Condition	Effect
	DEF	Check Engine	Stop Engine		
0	None			No Issue	None
1	 RED		OFF	Failure detected	None
2	 RED		OFF	1 hr after detected	25% derate
3	 RED		OFF	4 hrs after detected	40% derate
4	 RED		 1  2 May be ON	4 hrs after detected <i>and</i> any of the following: key cycle, refueled, or parked for 1hr	40% derate and max speed 5 mph



6

SCR System Fault Warning – Emergency Vehicles



Some vehicles may have a notification/information screen in addition to these icons. Additional messages may appear in your information center of the instrument cluster. The DEF warning light described in this table only applies to vehicles powered by PACCAR MX engines.

Stage	Warning Lights \ Indicators			Condition	Effect
	DEF	Check Engine or MIL ²⁴	Stop Engine		
0	OFF			No issue	None
1	 RED	 OR 	OFF	Failure detected	None
2	 RED	 OR 	OFF	1 hr after detected	None
3	 RED	 OR 	OFF	4 hrs after detected	None







²⁴ Depends on fault.

Stage	Warning Lights \ Indicators			Condition	Effect
	DEF	Check Engine or MIL ²⁴	Stop Engine		
4	 RED	 OR	OFF	4 hrs after detected <i>and</i> any of the following: key cycle, refueled, or parked for 1hr.	None

DPF Regeneration Required Notification

Stage	Warning Lights			Condition and Vehicle Actions	Operator Actions
	DEF	Check Engine	Stop Engine		
0	OFF			Acceptable amount of soot	None
1	 White	OFF	OFF	Soot is above the acceptable amount.	Enabling Automatic Regenerations on page 39
2	 Amber	OFF	OFF	Soot significantly exceeds acceptable amount.	Regenerate DPF as soon as possible: Enabling Automatic Regenerations on page 39 or Starting a Parked Regeneration on page 40

²⁴ Depends on fault.

Stage	Warning Lights			Condition and Vehicle Actions	Operator Actions
	DEF	Check Engine	Stop Engine		
3	 Red		OFF	Soot has filled the DPF Derate	Regenerate DPF immediately: <i>Starting a Parked Regeneration</i> on page 40
4	 Red		 1  2	DPF Critically Full Derate	DPF cannot be regenerated. Tow vehicle to a PACCAR Powertrain distributor to have DPF cleaned or replaced.

 **CAUTION**

The engine derate sequence is engine-specific; therefore, to learn how this system works on your vehicle, refer to the Engine Manufacturer's Operation and Maintenance Manual supplied with your vehicle. Failure to com-

ply may result in equipment or property damage.

 **WARNING**

If the Stop Engine warning lamp illuminates, it means you have a serious engine system problem. This should be considered an emergency. You should stop the vehicle as safely as possible

and turn OFF the ignition. The vehicle must be serviced and the problem corrected before driving again. Failure to comply may result in death, personal injury, equipment or property damage.

High Exhaust System Temperature (HEST) Notification

Warning Light	Condition	Operator Actions
---------------	-----------	------------------

	<p>Exhaust outlet temperature is elevated above normal (at least 842°F / 450°C) and vehicle slows below 5 mph (8 kph)²⁵ as a result of:</p> <ul style="list-style-type: none"> • Normal driving but engine is under heavy loading • Automatic regeneration in process • Parked regeneration in process 	<p>Follow warnings listed in this table. Use the DISABLE (or STOP) position on the DPF switch, or turn the ignition OFF if the situation requires: see Stopping a Regeneration on page 43.</p>
---	--	---

²⁵ Default setting.

**WARNING**

The exhaust system is hot while the engine is running and generates heat above 1000°F (538°C) during a regeneration. DO NOT touch or approach exhaust system components until they cool. During a diesel particulate filter (DPF) regeneration, the DPF and aftertreatment system becomes extremely hot, affecting the exhaust piping and surrounding structures, including enclosures and steps. Failure to comply may result in personal injury, or death.

**WARNING**

If the High Exhaust System Temperature (HEST) warning light is on, do not park near combustible vapors or materials. You must keep combustibles at least 5 ft. (1.5 m) away from the exhaust (outlet) stream as it exits the tail pipe while the HEST light is illuminated. Failure to do so could ignite an explosion and cause serious injury to bystanders.

**WARNING**

If the High Exhaust System Temperature (HEST) warning light is on, do not park near people. The heat generated by the engine aftertreatment system (EAS) may cause serious burns if EAS components are contacted. Failure to do so may result in property damage, personal injury, or death.

Index

Numerics

48 V Generator [19](#)

C

Canister Characteristics [12](#)
City Delivery [35](#)
Cleaning the DEF Coolant Filter [56](#)

D

DEF Handling [15](#)
DEF Level Warning
 Emergency Vehicles [63, 66, 69](#)
 Non-Emergency Vehicles [62, 65, 67](#)
DEF Pump Filter Replacement [53](#)
DEF Quality Warning
 Emergency Vehicles [63, 66, 69](#)
 Non-Emergency Vehicles [62, 65, 67](#)
Desorb, See Regeneration - DPF Warmup
Diesel Exhaust Fluid (DEF)
 Adding [35](#)
 Coolant Filter Cleaning [56](#)
 Level Gauge [23](#)
 Pump Filter Replacement [53](#)
 Warning Lights [24, 26, 28, 29](#)
Diesel Particulate Filter (DPF)
 Regenerations [37](#)
 Warmup [41](#)

Diesel Particulate Filter (DPF) System [13](#)

E

Extended Idling [36](#)

G

General Safety Instructions [6](#)

H

Heater Control Unit (HCU) MX-13 CARB Only [19](#)
High Exhaust System Temperature (HEST)
 Notification [71](#)
 Warning Light [29](#)

I

Idling in Freezing Temperatures, Extended [36](#)
Illustrations [6](#)

Indications

Diesel Exhaust Fluid (DEF) [14, 23, 26, 35, 53, 56](#)

M

Manual Regeneration, See Parked Regeneration

N

Notifications

- Low DEF Level [35](#)
- Poor DEF Quality [23](#)
- SCR System Fault [44](#)
- What are Notifications? [32](#)

P

- Poor DEF Quality Actions [23](#)
- Preventative Maintenance [47](#)

Preventative Maintenance Schedule

- Heavy Duty [49](#)
- Low Cab Forward [49](#)
- Medium Duty [50](#)

R

Regeneration

- Automatic [38](#)
 - DPF Warmup [41](#)
 - Enabling [39](#)
 - Exterior Notification [30](#)
 - Parked [39](#)
 - Regenerations [37](#)
 - Starting [40](#)
 - Stopping [43](#)
 - When to Perform [37](#)
- Regeneration Required Exterior Notification [30, 70](#)
- Replacing Emissions Related Parts [58](#)

S

- Safety Messages and Notes [5](#)

SCR System Fault Warning

- Actions [44](#)
- Emergency Vehicles [63, 66, 69](#)
- Non-Emergency Vehicles [62, 65, 67](#)
- Selective Catalytic Reduction (SCR) System [18](#)
- Stationary Regeneration. *See* Parked Regeneration

Switches

- DPF one-position [31](#)
- DPF Three-position [31](#)

U

- Use Category Definitions [49](#)

V

- Vehicle Emission Controls [11](#)

W

Warning Lights

- Check Engine [26](#)
 - Diesel Particulate Filter (DPF) [14, 28, 37, 41](#)
 - High Exhaust System Temperature (HEST) [29, 71](#)
 - Stop Engine [29](#)
 - Warning Lights and Indicators [24](#)
- Warning Symbols Quick Reference [61](#)
- When should a Regeneration be Performed?, *See* When to Perform a Regeneration
- When to Perform a Regeneration [37](#)



PACCAR^{inc}

P.O. Box 1518

Bellevue, WA 98009

Y53-6091-1F1